

www.iechocutter.com



WeChat



Website

Hangzhou IECHO Science & Technology Co., Ltd.

Address: No.1 Building, No.1 Weiye Road,
Binjiang District, Hangzhou, China

Tel: +86-571-86609560

Fax: +86-571-86698923

Email: info@iechosoft.com

www.iechocutter.com

IECHO

BK4

The new fourth-generation machine

HIGH SPEED DIGITAL
CUTTING SYSTEM

Inherit high quality / Continue the classic

Fast / Precise / Reliable



INTELLIGENT CUTTING CREATES FUTURE

INTELLIGENT IECHOMC Precision Motion Control

Maximum speed **1800** mm/s

IECHOMC motion control module makes the machine run more intelligently. Different motion strategies can be replaced at will and easily deal with the processing of different products in different industries.

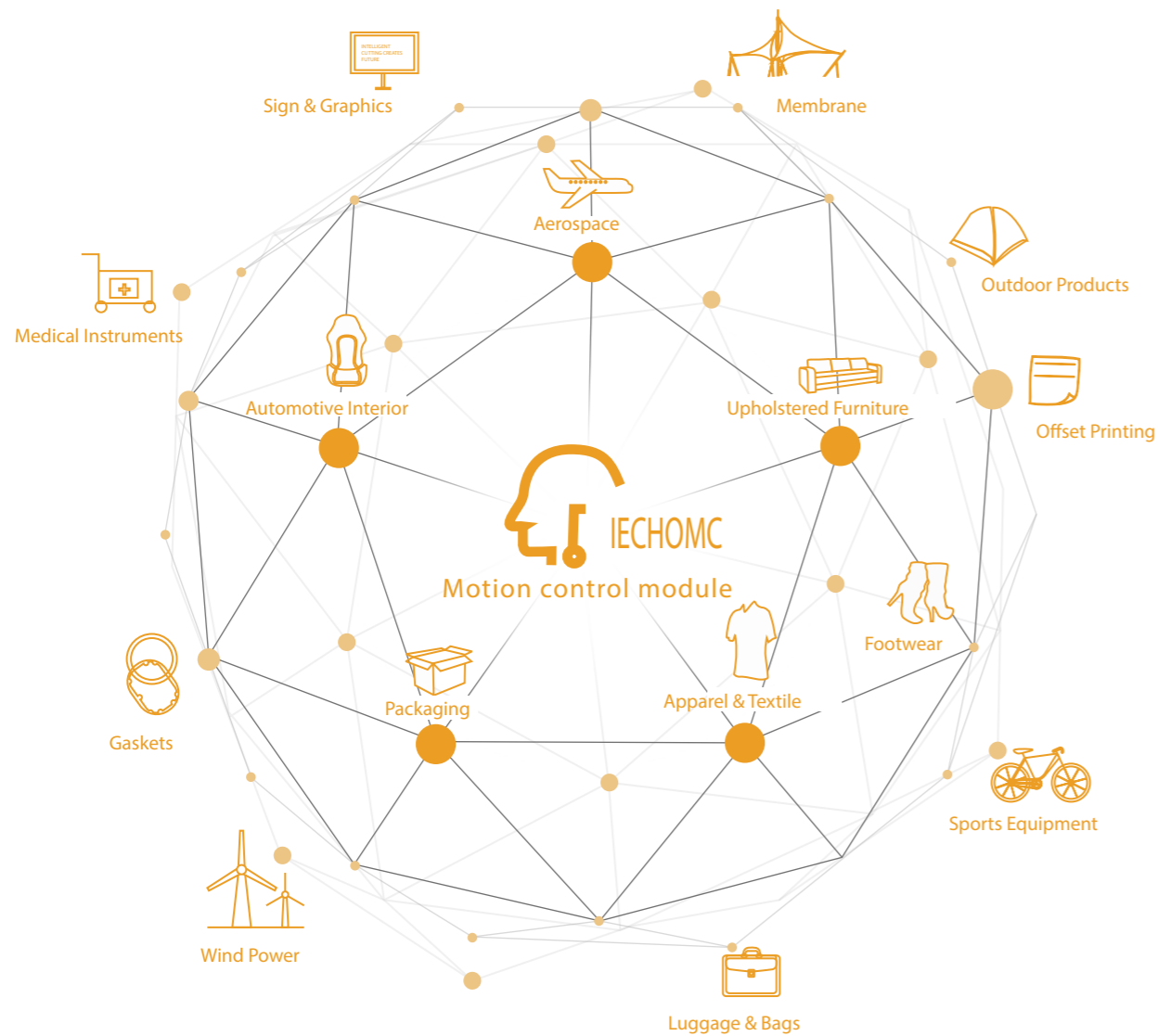

Ultra-high Strength Integrated Frame

12mm steel frame with qualified connection technology, the machine body frame weighs 600KG.
Strength increased by 30%, reliable and durable

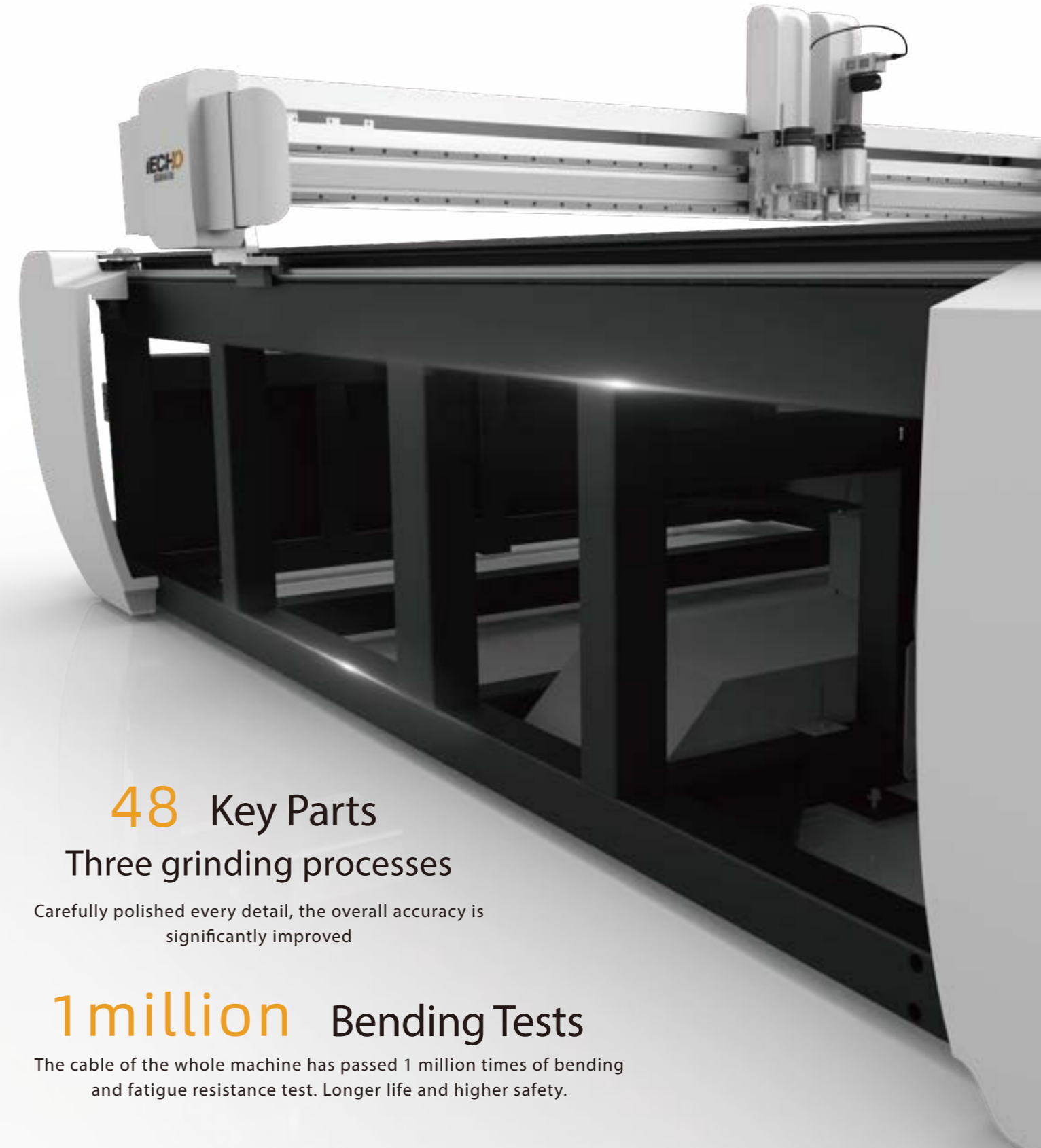

48 Key Parts

Three grinding processes

Carefully polished every detail, the overall accuracy is significantly improved

1 million Bending Tests

The cable of the whole machine has passed 1 million times of bending and fatigue resistance test. Longer life and higher safety.



Remote diagnosis
Quick diagnosis and solve problems remotely



Intelligent Optimization
Optimize cutting solution according to products.



Custom Development
Development of exclusive control software.



MES
Connect to various management systems



Exquisite Appearance Excellent Quality

Whole machine integrated molding, Stylish appearance
Appreciate the Beauty of Design

OUTSIDE

Textured body / Qualified choice

New Appearance

High-strength engineering materials

Hidden cable carrier

INSIDE

Superb Craftsmanship

New vacuum design
Air flow increased by 25%

Diagonal brace built in the gantry
Structural strength increased by 30%

Intelligent vacuum zones
Intelligently adjust suction
according to material size

Imported aviation aluminum table
Integrated molding, smooth and stable



Large flow pipeline design
Super suction



Standard configured Soundproof Box Create comfortable working environment

Latest upgraded mute system, noise reduction at the source.

Air circulation cooling Good heat dissipation

IECHO's newly developed air circulation cooling system efficiently dissipates heat and easily copes with harsh environments

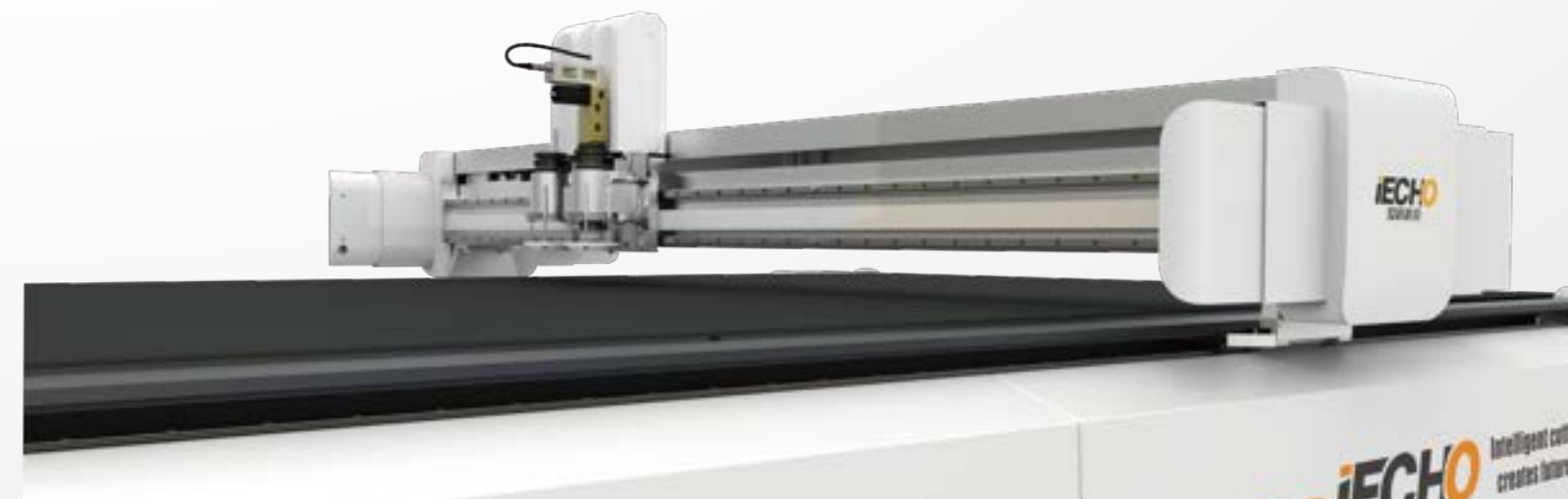

Coexistence of details and strength



Diversified cutting module configuration

Diversified cutting modules can be freely combined as needed, satisfying the cutting requirements for different materials in different industries.



Upgrade circuit layout

Newly upgraded circuit layout, more convenient operation.



Various material unwinding devices

Choose the correct unwinding device according to feature of the material.



Intelligent Conveyor System

Intelligent control of material transmission realizes the coordinated work of cutting and collecting, realized continuous cutting for super-long marker, saving labor and improved production efficiency.



PARAMETERS

Model	BK4-1312	BK4-2012	BK4-2513	BK4-2516
Effective cutting area(mm)	1300×1200	2000×1200	2500×1300	2500×1600
Machine dimension(mm)	2100×2000	2800×2000	3200×2100	3200×2400
Weight	600kg-900kg			
Maximum cutting speed	1800mm/s			
Maximum cutting thickness	50mm			
Cutting precision	0.1mm			
File format	DXF /HPGL			
Suction media	Vacuum			
Pump power	7.5KW/9KW			
Electric power	220V/50HZ 380V/50HZ			
Operation environment	Temperature: 0°C-40°C Humidity: 20%-80%RH			

VARIETY OF TOOLS FOR YOUR SELECTION

— Meet all your processing requirements

IECHO V-CUT



A dedicated tool used for corrugated and sandwich materials to make V groove, can change blade slope (0°, 15°, 22.5°, 30°, 45°) to achieve different results.

IECHO CTT



Used for making creases on corrugated and similar materials. It can crease perfectly by different types of wheels. By controlling the cutting software, creasing tool can process along corrugated direction or in different direction, to obtain high quality creases.

IECHO UCT

UCT can cut materials up to 5mm thickness with fast speed. Comparing with the other tools, UCT is the most cost-effective tool. It has three types of blade holders for different blades.



IECHO RZ

The imported spindle with 350W power is used. According to different materials and applications, the speed can be up to 60000 RPM. The high-frequency rotor-driven module is used to cut hard materials and foam materials with a thickness of 20mm. The high-speed and high-efficiency processing performance is better than traditional processing way, which can meet the 24/7 production need. Specially equipped cleaning device minimizes the debris and the air cooling system extends the life time of the spindle and blades.



IECHO POT

Driven by compressed air, 8mm stroke suits very well for foam material cutting such as honeycomb board, and suited for multiple types of materials, with special blade it can cut up to 60mm thickness.



IECHO KCT

Mainly used for cutting vinyl (sign, sticker material), by adjusting blade position it can cut material with precise depth, cut accurately the upper layer without damaging under layer with fast speed.



IECHO EOT

The high-frequency vibration of the brushless DC motor cuts the material, which is suitable for cutting medium-density materials. With a wide variety of blades, it is suitable for processing different materials, and can process a minimum of 2mm arc.



IECHO DRT

The brushless DC motor drives the blade to rotate and cut the material at high speed. It can be equipped with round blades or 10-angle blades. It is particularly suitable for cutting woven materials, which can significantly reduce the drag force and help to cut each fiber or thread completely.



IECHO EOT4

EOT4 is used to process sandwich/honeycomb board material, corrugated board, thick carton board and strength leather. It has 2.5mm stroke, can cut thick and dense material with high speed. It is equipped with air cooling system to extend blade lifespan.



IECHO PRT

Compared with DRT, the PRT with its strong power performance is suited for wider range of materials, can cut easily the challenging materials like glass fiber and aramid fiber. It has air cooling system to reduce motor temperature to expand its lifespan.



Quality recommendation Simplify your choice

100+ Service offices

IECHO digital cutting machine, professional guarantee, worldwide service offices

The new fourth-generation machine BK4 high-speed digital cutting system, for single layer (few layers) cutting, can work automatically and accurately process like through cut, kiss cut, milling, v groove, creasing, marking, etc. It can be widely used in the industries of automotive interior, advertising, apparel, furniture and composite, etc. BK4 cutting system, with its high precision, flexibility and high efficiency, provides automated cutting solutions to variety of industries.



9 invention patents
30 utility models and appearance patents



APPLICATION INDUSTRIES



Composites



Print & Packaging

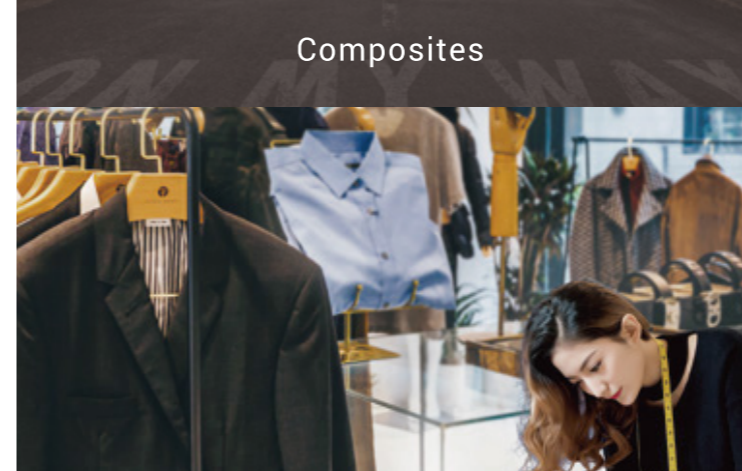

Textile & Apparel

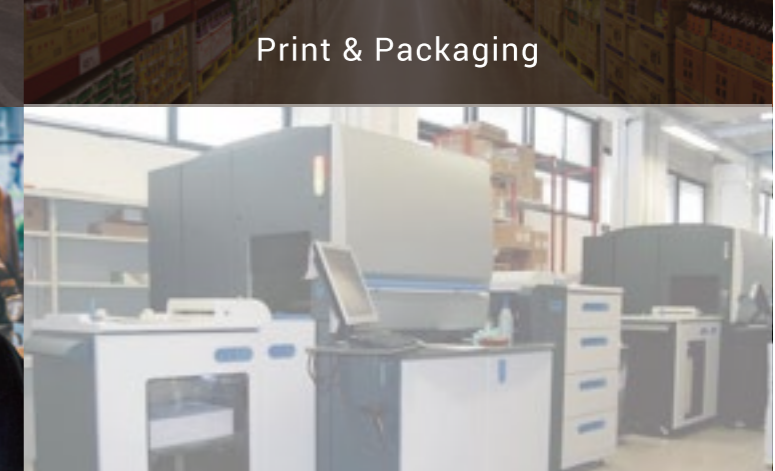

Offset printing

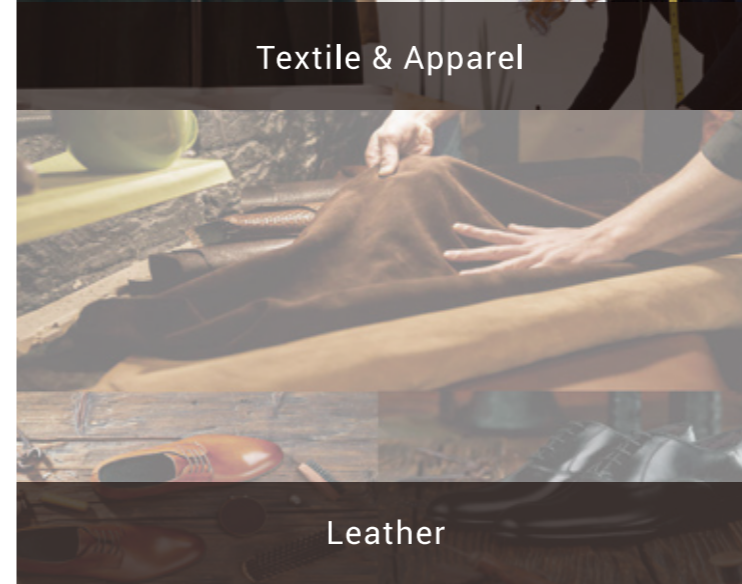

Leather



Automotive

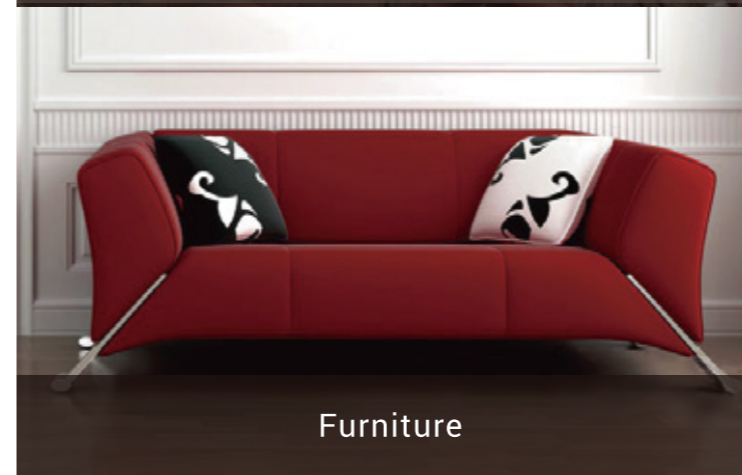

Furniture

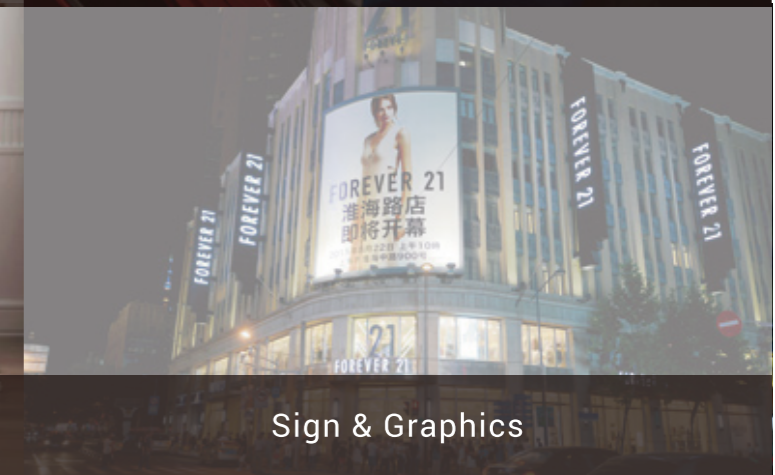

Sign & Graphics